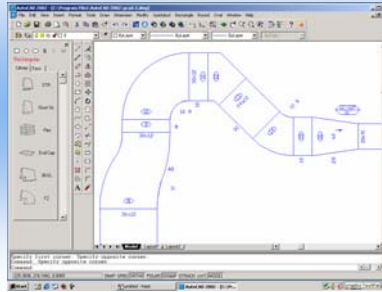
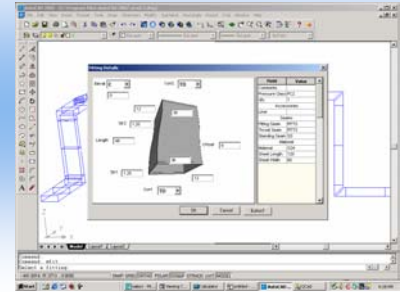
**Auto Route****Auto Dimension****Edit Fitting**

- ◆ **Automatic Dimensioning**
- ◆ **Automatic Routing**
- ◆ **Full 3D Drawings**
- ◆ **Purchase Item Support**
- ◆ **Picture/Prompt Editing**
- ◆ **CAM Downloading**

### **Incredible Drawing power with seamless CAM interface**

Quickduct CAD's powerful features take the manual effort out of time consuming shop drawings. Automatic features for dimensioning, tagging and duct routing reduce hours of work to just minutes. Like our CAM system, Quickduct CAD offers all the "extras" that you would find only in a system developed by sheet metal experts. A complete rectangle, round and flat oval fitting library gives you everything you need to design and draw the most complex jobs.

**Fully AutoCad compatible Object ARX design** allows all standard AutoCad tools to be used including undo, move, copy, etc.

### **Seamless interface to Quickduct CAM**

Shop Data has seamlessly integrated the QuickDuct CAD & CAM systems which means, once the drawing is completed, you're a couple of mouse clicks away from pattern layouts, nesting and cutting.

Since QuickDuct is "Fabrication Smart", if it can't be built, it won't be drawn.

Fully compatible shop standards between CAD & CAM assure no downloading problems.



## Comprehensive library provides ultimate flexibility

The HVAC Fittings library includes rectangle, round and flat oval fitting shapes accessible from a dockable picture toolbar or drop down menu. Capabilities such as mitering, reducing, concentric/eccentric dimensioning are available as well as dual wall and inside/outside diameter material compensation.

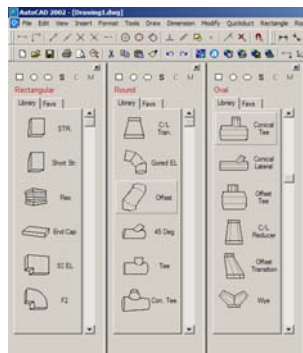

## Auto-Routing

Quickduct CAD's automatic routing utility makes routing from point to point a one click operation. The routes allow elevation or offset changes for rectangular and oval duct lines and allow both elevation

and offset for rolling round offset routes. Round routes also ask for length of flex to be applied to the end of the route for easy tap-to-grill routing. All routes allow an elevation override so you can continue to use 2D snap points. This makes it easy to draw on top of existing drawing layers or overlays.

Additionally, Quickduct CAD automatically adjusts throat sizes of elbows in routes up to a user specified maximum to eliminate additional small, costly short joints.

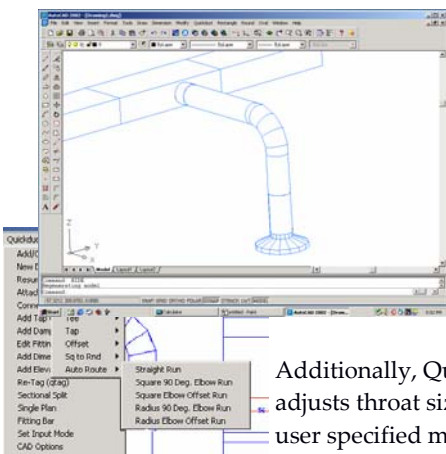

## Auto Connect

Connecting between two ducts is easy with Quickduct CAD. Just select the two ducts and choose the type of transitioning duct you would like to use whether it be a simple transition, a square offset, or a radius O.G.

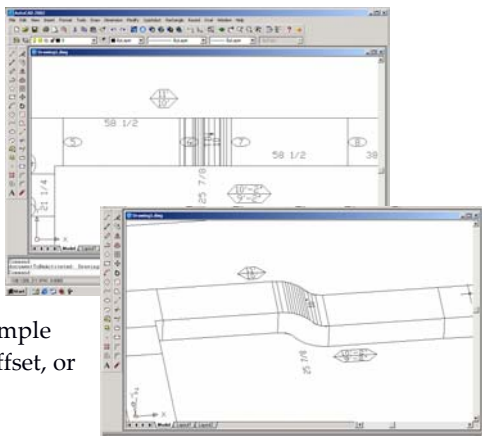

## Automatic Dimensioning

One of the most time consuming parts of any CAD drawing is dimensioning and tagging. Quickduct CAD automatically dimensions size, length, offset, angle and elevation changes. User preferences are supplied for dimension orientation and a smart-

rotation is applied to all dimensions which assure that they can be read from a fixed vantage point. All dimensions are individually selectable and movable for easier identification on tightly cramped areas.

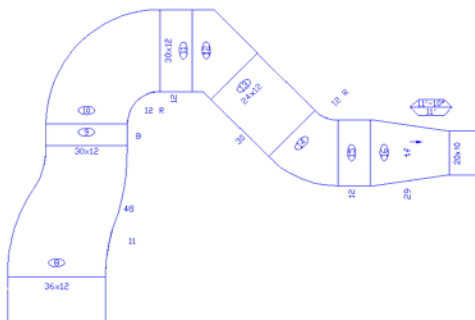

## Selective Dimensioning

Any dimension can be deleted, edited or changed on the drawing. Additional non-standard dimensions/comments can be placed and associated with any fitting.

That means if the fitting is moved, the dimensions, comments and tags will move with it.

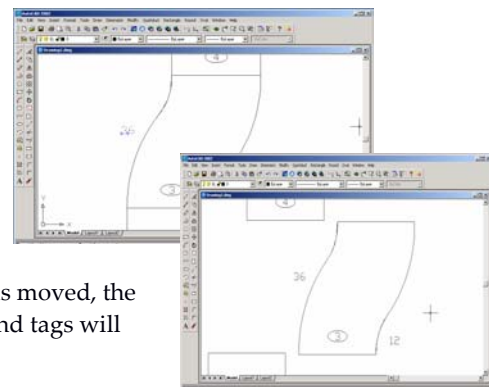

## Automatic Tagging

Another time consuming function is made easy with this helpful utility. A user preference for tagging sequence is supplied for trunk first or tap line first options. Tags can be set for individual tagging or exact-match, duplicate tagging. Tag prefixes by duct line/unit are also supported.

## Picture Edit

Quickduct CAD's picture edit make checking and modifying simple and easy. Changes made to the fitting automatically update the drawing.

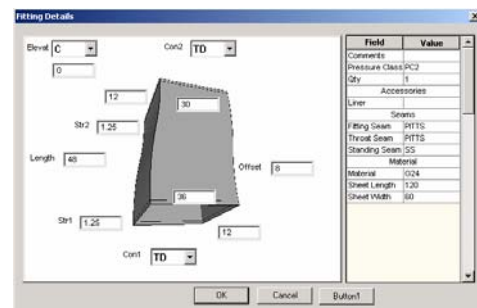

## Incredible user-definable shop standards

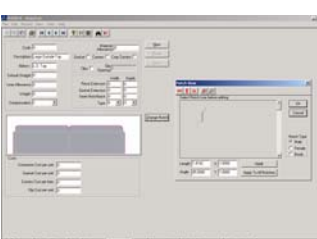

ShopData allows you to customize your HVAC software. Use standard industry pressure classes, or define your own pressure classes and construction tables. Define seams, connectors, vanes, materials and more. Enter your actual costs for accurate job costing!

## Open Architecture design for Ultimate customization of reports

Through the dynamic interactive capabilities of Microsoft Windows® you can design your own ShopData reports! By interfacing Microsoft Access® and Seagate Crystal Reports™ with ShopData for Windows, you have the tools you need to extract critical data for estimating, production, shipping, inventory management, purchasing and more.

## CAD to CAM

Direct download from QuickDuct CAD into our fabrication software. All fittings and shop standards are completely compatible for a seamless interface. Simply download the job, nest and cut.

## Personalized training & support

ShopData backs its software with 120+ collective years of metal fabricating experience and 28+ years in business. No cutting software company has more expertise! We offer hands-on, customized training at your site or ours. Take advantage of our 24/7 phone support through the annual ShopSource Support and Upgrade program.

**SHOP DATA**  
SYSTEMS

**SDS**

Shop Data Systems, Inc.  
712 East Walnut Street.  
Garland, Texas 75040  
972-494-2719  
Fax 972-272-7062  
www.shopdata.com